

HSMS-286P

High frequency detector diode

Description



Lifecycle status: **Active**

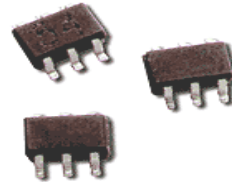

Features

The HSMS-286F family of biased detector diodes have been designed and optimised for use from 915MHz to 5.8GHz. They are ideal for RF/ID and RF tag applications as well as large signal detection, modulation, RF to DC conversion or voltage doubling. $V_{BR}=4\text{ V}$, $C_T=0.3\text{ pF}$, $R_D@5\text{mA}=14\text{ Ohms}$, $V_f @ 1\text{ mA}=350\text{ mV}$

Data Sheet

Description

Avago's HSMS-286x family of DC biased detector diodes have been designed and optimized for use from 915 MHz to 5.8 GHz. They are ideal for RF/ID and RF Tag applications as well as large signal detection, modulation, RF to DC conversion or voltage doubling.

Available in various package configurations, this family of detector diodes provides low cost solutions to a wide variety of design problems. Avago's manufacturing techniques assure that when two or more diodes are mounted into a single surface mount package, they are taken from adjacent sites on the wafer, assuring the highest possible degree of match.

Pin Connections and Package Marking

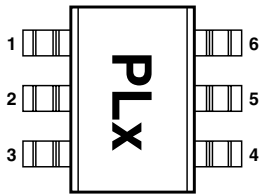

Notes:

1. Package marking provides orientation and identification.
2. The first two characters are the package marking code.
The third character is the date code.

Features

- Surface Mount SOT-23/SOT-143 Packages
- Miniature SOT-323 and SOT-363 Packages
- High Detection Sensitivity:
 - up to 50 mV/μW at 915 MHz
 - up to 35 mV/μW at 2.45 GHz
 - up to 25 mV/μW at 5.80 GHz
- Low FIT (Failure in Time) Rate*
- Tape and Reel Options Available
- Unique Configurations in Surface Mount SOT-363 Package
 - increase flexibility
 - save board space
 - reduce cost
- HSMS-286K Grounded Center Leads Provide up to 10 dB Higher Isolation
- Matched Diodes for Consistent Performance
- Better Thermal Conductivity for Higher Power Dissipation
- Lead-free Option Available

* For more information see the Surface Mount Schottky Reliability Data Sheet.

SOT-23 / SOT-143 Package Lead Code Identification (top view)

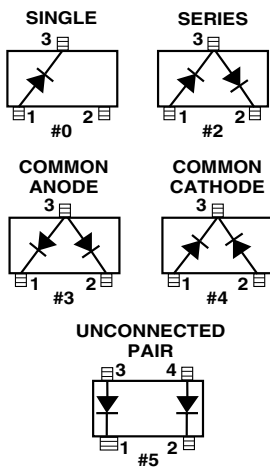

SOT-323 Package Lead Code Identification (top view)

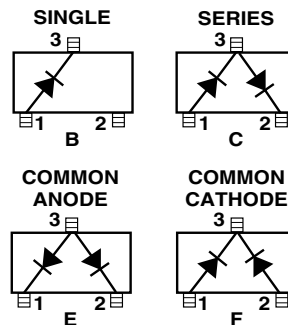

SOT-363 Package Lead Code Identification (top view)

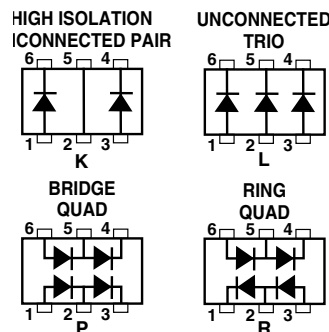

SOT-23/SOT-143 DC Electrical Specifications, $T_c = +25^\circ\text{C}$, Single Diode

Part Number HSMS-	Package Marking Code	Lead Code	Configuration	Forward Voltage V_F (mV)		Typical Capacitance C_T (pF)
2860	T0	0	Single	250 Min.	350 Max.	0.30
2862	T2	2	Series Pair ^[1,2]			
2863	T3	3	Common Anode ^[1,2]			
2864	T4	4	Common Cathode ^[1,2]			
2865	T5	5	Unconnected Pair ^[1,2]			
Test Conditions				$I_F = 1.0 \text{ mA}$		$V_R = 0 \text{ V}, f = 1 \text{ MHz}$

Notes:

1. ΔV_F for diodes in pairs is 15.0 mV maximum at 1.0 mA.
2. ΔC_T for diodes in pairs is 0.05 pF maximum at -0.5V .

SOT-323/SOT-363 DC Electrical Specifications, $T_c = +25^\circ\text{C}$, Single Diode

Part Number HSMS-	Package Marking Code	Lead Code	Configuration	Forward Voltage V_F (mV)		Typical Capacitance C_T (pF)
286B	T0	B	Single	250 Min.	350 Max.	0.25
286C	T2	C	Series Pair ^[1,2]			
286E	T3	E	Common Anode ^[1,2]			
286F	T4	F	Common Cathode ^[1,2]			
286K	TK	K	High Isolation Unconnected Pair			
286L	TL	L	Unconnected Trio			
286P	TP	P	Bridge Quad			
286R	ZZ	R	Ring Quad			
Test Conditions				$I_F = 1.0 \text{ mA}$		$V_R = 0 \text{ V}, f = 1 \text{ MHz}$

Notes:

1. ΔV_F for diodes in pairs is 15.0 mV maximum at 1.0 mA.
2. ΔC_T for diodes in pairs is 0.05 pF maximum at -0.5V .

RF Electrical Specifications, $T_C = +25^\circ\text{C}$, Single Diode

Part Number	Typical Tangential Sensitivity TSS (dBm) @ f =			Typical Voltage Sensitivity g (mV/ μW) @ f =			Typical Video Resistance RV (K Ω)
	915 MHz	2.45 GHz	5.8 GHz	915 MHz	2.45 GHz	5.8 GHz	
2860	-57	-56	-55	50	35	25	5.0
2862							
2863							
2864							
2865							
286B							
286C							
286E							
286F							
286K							
286L							
286P							
286R							
Test Conditions	Video Bandwidth = 2 MHz $I_b = 5 \mu\text{A}$			Power in = -40 dBm $R_L = 100 \text{K}\Omega$, $I_b = 5 \mu\text{A}$			$I_b = 5 \mu\text{A}$

Absolute Maximum Ratings, $T_C = +25^\circ\text{C}$, Single Diode

Symbol	Parameter	Unit	Absolute Maximum ^[1]	
			SOT-23/143	SOT-323/363
P_{IV}	Peak Inverse Voltage	V	4.0	4.0
T_J	Junction Temperature	$^\circ\text{C}$	150	150
T_{STG}	Storage Temperature	$^\circ\text{C}$	-65 to 150	-65 to 150
T_{OP}	Operating Temperature	$^\circ\text{C}$	-65 to 150	-65 to 150
θ_{jc}	Thermal Resistance ^[2]	$^\circ\text{C}/\text{W}$	500	150

Notes:

- Operation in excess of any one of these conditions may result in permanent damage to the device.
- $T_C = +25^\circ\text{C}$, where T_C is defined to be the temperature at the package pins where contact is made to the circuit board.



Attention:
Observe precautions for handling electrostatic sensitive devices.

ESD Machine Model (Class A)

ESD Human Body Model (Class 0)

Refer to Avago Application Note A004R: Electrostatic Discharge Damage and Control.

Diode Burnout

Any Schottky junction, be it an RF diode or the gate of a MESFET, is relatively delicate and can be burned out with excessive RF power. Many crystal video receivers used in RFID (tag) applications find themselves in poorly controlled environments where high power sources may be present. Examples are the areas around airport and FAA radars, nearby ham radio operators, the vicinity of a broadcast band transmitter, etc. In such environments, the Schottky diodes of the receiver can be protected by a device known as a limiter diode.^[6] Formerly available only in radar warning receivers and other high cost electronic warfare applications, these diodes have been adapted to commercial and consumer circuits.

Avago offers a complete line of surface mountable PIN limiter diodes. Most notably, our HSMP-4820 (SOT-23) or HSMP-482B (SOT-323) can act as a very fast (nano-second) power-sensitive switch when placed between the antenna and the Schottky diode, shorting out the RF circuit temporarily and reflecting the excessive RF energy back out the antenna.

Assembly Instructions

SOT-323 PCB Footprint

A recommended PCB pad layout for the miniature SOT-323 (SC-70) package is shown in Figure 33 (dimensions are in inches).

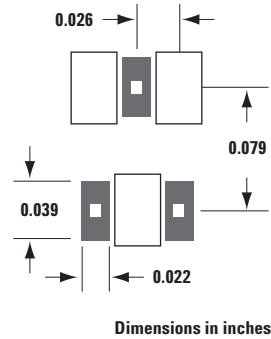

Figure 33. Recommended PCB Pad Layout for Avago's SC70 3L/SOT-323 Products.

A recommended PCB pad layout for the miniature SOT-363 (SC-70 6 lead) package is shown in Figure 34 (dimensions are in inches). This layout provides ample allowance for package placement by automated assembly equipment without adding parasitics that could impair the performance.

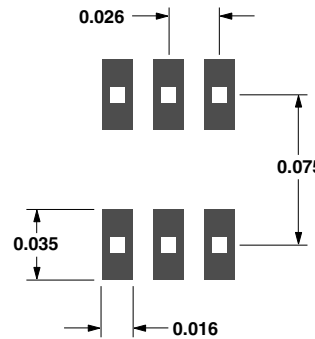
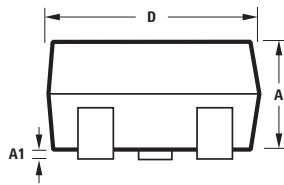
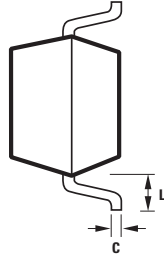
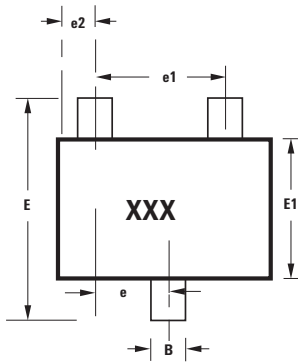

Figure 34. Recommended PCB Pad Layout for Avago's SC70 6L/SOT-363 Products.

Package Dimensions Outline 23 (SOT-23)



SYMBOL	DIMENSIONS (mm)	
	MIN.	MAX.
A	0.79	1.20
A1	0.000	0.100
B	0.37	0.54
C	0.086	0.152
D	2.73	3.13
E1	1.15	1.50
e	0.89	1.02
e1	1.78	2.04
e2	0.45	0.60
E	2.10	2.70
L	0.45	0.69

Notes:
XXX-package marking
Drawings are not to scale

Outline SOT-323 (SC-70 3 Lead)

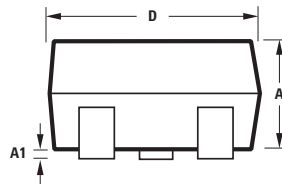
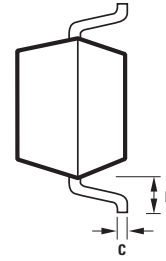
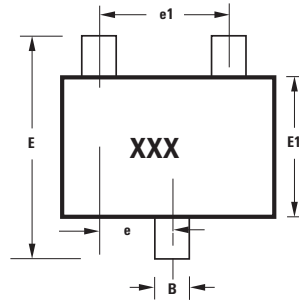

SYMBOL	DIMENSIONS (mm)	
	MIN.	MAX.
A	0.80	1.00
A1	0.00	0.10
B	0.15	0.40
C	0.10	0.20
D	1.80	2.25
E1	1.10	1.40
e	0.65 typical	
e1	1.30 typical	
E	1.80	2.40
L	0.425 typical	

Notes:
XXX-package marking
Drawings are not to scale

Outline 143 (SOT-143)

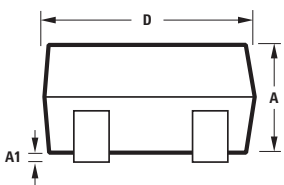
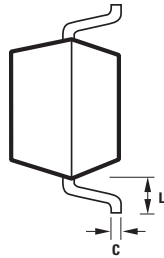
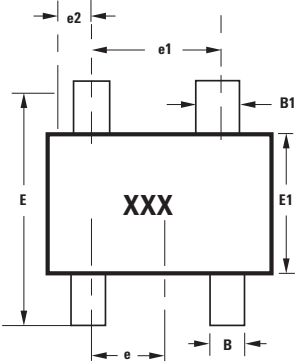

SYMBOL	DIMENSIONS (mm)	
	MIN.	MAX.
A	0.79	1.097
A1	0.013	0.10
B	0.36	0.54
B1	0.76	0.92
C	0.086	0.152
D	2.80	3.06
E1	1.20	1.40
e	0.89	1.02
e1	1.78	2.04
e2	0.45	0.60
E	2.10	2.65
L	0.45	0.69

Notes:
XXX-package marking
Drawings are not to scale

Outline SOT-363 (SC-70 6 Lead)

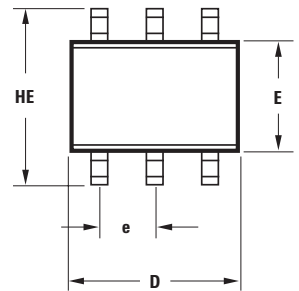

SYMBOL	DIMENSIONS (mm)	
	MIN.	MAX.
E	1.15	1.35
D	1.80	2.25
HE	1.80	2.40
A	0.80	1.10
A2	0.80	1.00
A1	0.00	0.10
Q1	0.10	0.40
e	0.650 BCS	
b	0.15	0.30
c	0.10	0.20
L	0.10	0.30

